



rubicer

BASES

24 ANOS
A Transformar
Ambientes.



BASES DE CHUVEIRO

Shower trays
Receveurs de douche
Platos de ducha
Duschwannen



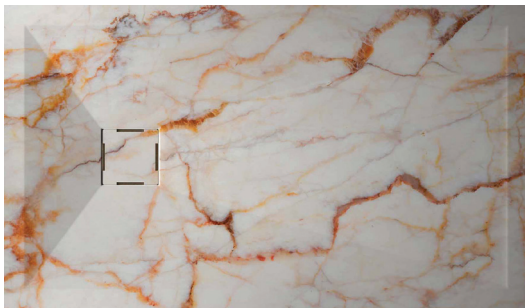

MARBLE CREAM ORO **S200/280**

Cód.: RBMIMP3DMCO

Base não incluída / tray not included
receveur non inclus / plato no incluido



5 606779 256225



LIGHT EMPERADOR **S200/280**

Cód.: RBMIMP3DLEM

Base não incluída / tray not included
receveur non inclus / plato no incluido



5 606779 256232



FOLHAS 01 **S200/280**

Cód.: RBMIMP3DFO01

Base não incluída / tray not included
receveur non inclus / plato no incluido



5 606779 251411

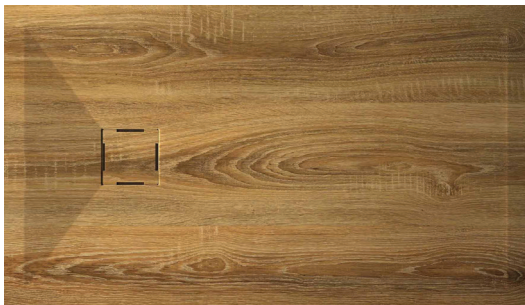

RBMIMP3DOAK **S200/280**

Cód.: RBMIMP3DOAK

Base não incluída / tray not included
receveur non inclus / plato no incluido



5 606779 256249



RUST **S200/280**

Cód.: RBMIMP3DRUST

Base não incluída / tray not included
receveur non inclus / plato no incluido



5 606779 256263

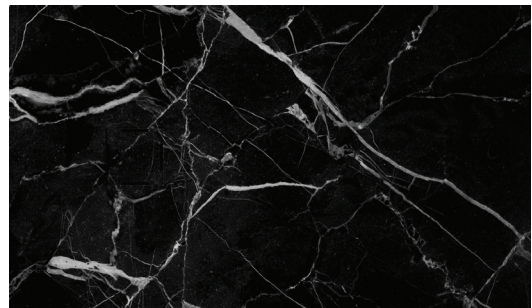

BLACK MARBLE **S200/280**

Cód.: RBMIMP3DBLM

Base não incluída / tray not included
receveur non inclus / plato no incluido



5 606779 251367

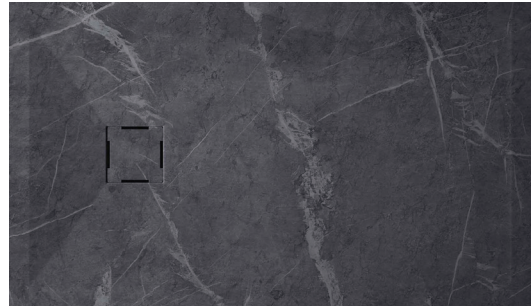

MARQUINA **S200/280**

Cód.: RBMIMP3DMA

Base não incluída / tray not included
receveur non inclus / plato no incluido



5 606779 251374

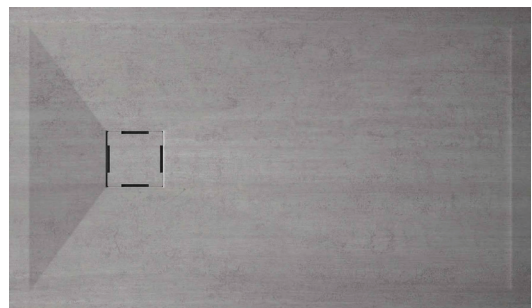

CEMENTO **S200/280**

Cód.: RBMIMP3DCE

Base não incluída / tray not included
receveur non inclus / plato no incluido



5 606779 251381



VINTAGE **S200/280**

Cód.: RBMIMP3DVIN

Base não incluída / tray not included
receveur non inclus / plato no incluido



5 606779 256256

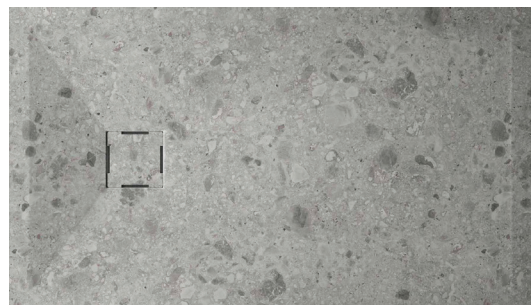

TERRAZZO GREY **S200/280**

Cód.: RBMIMP3DTEG

Base não incluída / tray not included
receveur non inclus / plato no incluido



5 606779 251398

Mineral

The most versatile shower tray on the market. Allows the simulation of noble materials, industrial finishes, natural shapes... creating a unique shower.

Le receveur de douche le plus polyvalent du marché, elle permet la simulation de matériaux nobles, de finitions industrielles, de formes naturelles, créant une douche unique

El plato de ducha más versátil del mercado. Permite la simulación de materiales nobles, acabados industriales, formas naturales... creando una ducha única.

A Base mais versátil do mercado. Permite a simulação de materiais nobres, acabamentos industriais, formas naturais... criando um duche único.



- ACABAMENTO: LISO MATE
- SUPERFÍCIE: GEL COAT
- ESPESSURA: 3cm
- GRELHA INOX C/ IMPRESSÃO EM 1 FACE

- FINISHING: SMOOTH MATT
- SURFACE: GEL COAT
- THICKNESS: 3cm
- STAINLESS STEEL GRID WITH 1-SIDED PRINT

- FINITION: MATE LISSE
- SURFACE: GEL COAT
- ÉPAISSEUR: 3cm
- GRILLE EN ACIER AVEC IMPRESSION SUR 1 FACE

- ACABADO: LISO MATE
- SUPERFÍCIE: GEL COAT
- GROSOR: 3cm
- REJILLA IMPRESA 1 CARA

WHITE MARBLE

S200/280

Cód.: RBMIMP3DWM

Base não incluída / tray not included / receveur non inclus / plato no incluido



5 606779 251404

A impressão realiza-se sobre uma base "Mineral" branca com acabamento LISO, à qual deve-se adicionar o código da impressão (1 unico código de impressão para qualquer dimensão de base).

Inclui grelha com impressão em 1 face.

Apenas disponível no modelo Mineral.

Printing is carried out on a white "Mineral" shower tray with a SMOOTH finish, to which the printing code must be added (1 single Print code for any shower tray dimension).

Includes grid with 1-sided printing.

Only available in "Mineral" model.

L'impression est réalisée sur un receveur "Mineral" blanche avec une finition LISSE à laquelle il faut ajouter le code d'impression (code d'impression unique pour tout les dimensions de base douche).

Comprend une grille avec impression sur la face supérieur.

Uniquement disponible sur notre modèle "Mineral".

La impresión se realiza sobre una base "Mineral" blanca con acabado LISO, a la que hay que añadir el código de impresión (1 código de impresión único para cualquier dimensión base).

Incluye rejilla con impresión a 1 cara.

Solo disponible en modelo "Mineral".

Outras cores

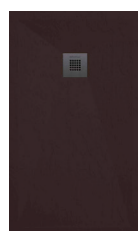

CHOCOLATE
RAL 8017



MOKA
NCS
S4010 Y 30R

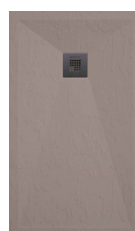

AREIA
NCS
S3005 Y50S



CREME
RAL 1015



BRANCO
RAL 9003



GRIS
NCS
S1510 B



GRIS
RAL 7035

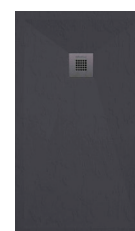

ANTRACITE
RAL 7011



NEGRO
RAL 9005



Comprimento Length longueur Länge / Largo	BLACK AND WHITE Largura / width / Largeur / Breite / Ancho						
	70 cm	80 cm	90 cm	100 cm	110 cm	120 cm	130 cm
70 cm	B107/149	-	-	-	-	-	-
80 cm	B122/171	B139/195	-	-	-	-	-
90 cm	B137/192	B157/219	B176/247	-	B479/670	B574/803	B688/963
100 cm	B152/213	B174/244	B196/274	B218/305	B511/716	B612/857	B734/1028
110 cm	B168/235	B191/268	B215/302	B240/336	B560/784	B672/941	B808/1131
120 cm	B183/256	B209/292	B235/329	B261/366	B601/842	B721/1009	B868/1215
130 cm	B198/277	B226/317	B255/356	B283/397	B623/872	B751/1051	B900/1260
140 cm	B213/299	B244/341	B274/384	B305/427	B645/902	B775/1085	B930/1302
150 cm	B228/320	B261/366	B294/411	B327/458	B658/922	B797/1116	B949/1329
160 cm	B244/341	B279/390	B313/439	B349/488	B677/948	B813/1139	B979/1371
170 cm	B259/363	B296/414	B333/466	B371/519	B781/1093	B936/1310	B1126/1577
180 cm	B274/384	B313/439	B353/494	B392/549	B813/1139	B974/1363	B1170/1637
190 cm	B289/405	B331/463	B372/521	B414/580	B868/1215	B1039/1455	B1248/1748
200 cm	B305/426	B348/487	B392/548	B436/610	B911/1276	B1093/1531	B1314/1839
210 cm	B320/448	B366/512	B411/576	B458/641	B957/1340	B1148/1607	B1382/1934
220 cm	B525/735	B585/819	B713/998	B808/1131	B1006/1409	B1205/1687	B1450/2030
230 cm	B558/781	B626/876	B759/1062	B860/1203	B1050/1470	B1265/1771	B1523/2132
240 cm	B582/815	B666/933	B792/1108	B898/1257	B1112/1557	B1327/1858	B1599/2239
250 cm	B620/868	B707/990	B840/1177	B952/1333	B1159/1622	B1393/1950	B1686/2361

Obs.
> Nas dimensões intermédias o código correspondente é o da medida maior (ex. 164x78cm = 170x80cm)

Obs.
> In the intermediate measures the code is over the larger measure (ex. 164x78cm = 170x80cm)

Obs.
> Pour une dimension intermédiaire considérer la dimension supérieure (ex. 164x78cm = 170x80cm)

Obs.
> En una medida intermedia del código está sobre la medida más grande (ex. 164x78cm = 170x80cm)

- ACABAMENTO: ARDÓSIA MATE
- SUPERFÍCIE: Gel Coat
- ESPESSURA: 3cm
- OUTRAS CORES: + 10%
- GRELHA INOX

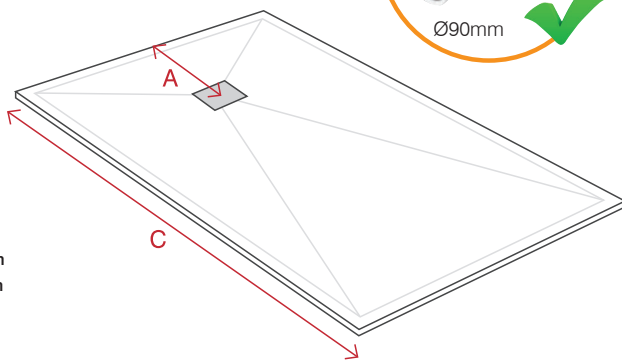

C ≤ 120cm A = 35cm
 C ≤ 150cm A = 40cm
 C ≤ 170cm A = 45cm
 C ≤ 200cm A = 50cm
 C ≤ 220cm A = 60cm

Cores Standard Standard Colors



areia
RAL 1013



negro
RAL 9005



antracite
RAL 7021



gris
RAL 7004



branco
RAL 9003



Mais de 150 cores disponíveis
More than 150 colors available

CORTES ESPECIAIS: 30/42
SPECIAL COLORS

GRELHAS COLORIDAS: 20/28
COLORED GRIDS

OUTRAS CORES: 70/98
ANOTHER COLORS

As bases de duche são revestidas a GEL COAT caracterizado por:

- Zero absorção de água.
- Dureza de 45 na escala de Barcol.
- Alta resistência a riscos.
- Anti-bacteriológico.
- Anti-derrapante.
- Resistente a altas temperaturas.
- Resistente a agentes químicos.
- Personalizável de acordo com as necessidades do cliente.
- Espessura de aprox. 3 cm.

Nos receveurs sont recouverts avec GEL COAT qui se caractérise par:

- Nulle absorption de l'eau.
- Dureté Barcol: 45.
- Étonnante résistance aux rayures.
- Antibactérienne.
- Antidérapant.
- Résistance aux hautes températures.
- Agent chimiques.
- Personnalisable selon les demandes des clients.
- Épaisseur dureceveur: 3 cm environ.

Our shower trays are covered by GEL COAT characterized by:

- Zero water absorption.
- 45 Barcol hardness.
- High scratch resistance.
- Antibacterial.
- Anti-slip.
- High temperature resistance.
- Chemical agents.
- Customizable according to customer needs.
- Its width is approximately 3 cm.

Nuestros platos están recubiertos en GEL COAT caracterizado por:

- Nula absorción del agua.
- Dureza en la escala de Barcol de 45.
- Alta resistencia al rayado.
- Antibacterias.
- Antideslizante.
- Resiste el cambio de temperatura.
- Agentes químicos.
- Personalizable por el cliente.
- Su grosor es de 3 cm. aprox.

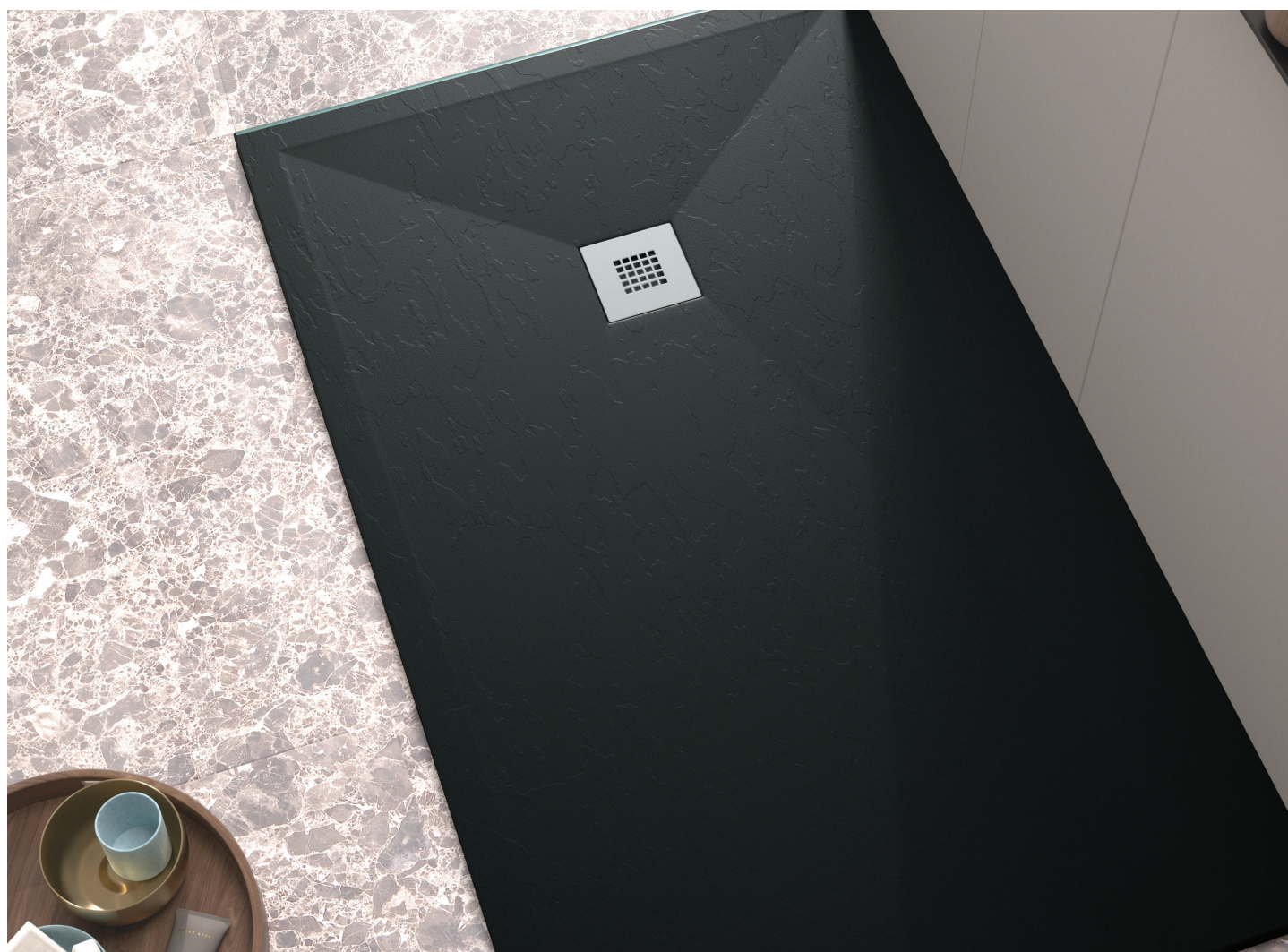
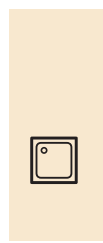

Comprimento Length longueur Länge / Largo	BLACK AND WHITE Largura / width / Largeur / Breite / Ancho		
	70 cm	80 cm	90 cm
70 cm	B135/189	-	-
80 cm	B154/216	B176/246	-
90 cm	B173/243	B198/277	B223/312
100 cm	B193/270	B220/308	B248/347
110 cm	B212/296	B242/339	B272/381
120 cm	B231/323	B264/370	B297/416
130 cm	B250/350	B286/400	B322/450
140 cm	B270/377	B308/431	B347/485
150 cm	B289/404	B330/462	B371/520
160 cm	B308/431	B352/493	B396/554
170 cm	B327/458	B374/524	B421/589
180 cm	B347/485	B396/554	B446/624
190 cm	B366/512	B418/585	B470/658
200 cm	B385/539	B440/616	B495/693
210 cm	B404/566	B462/647	B520/728

Obs.
> Nas dimensões intermédias o código correspondente é o da medida maior (ex. 164x78cm = 170x80cm)

Obs.
> In the intermediate measures the code is over the larger measure (ex. 164x78cm = 170x80cm)

Obs.
> Pour une dimension intermédiaire considérer la dimension supérieure (ex. 164x78cm = 170x80cm)

Obs.
> En una medida intermedia del código está sobre la medida más grande (ex. 164x78cm = 170x80cm)

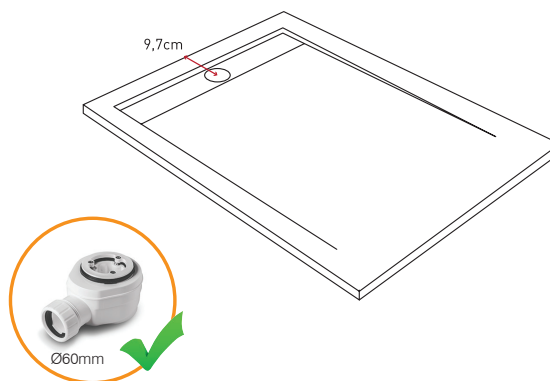

OUTRAS CORES: + 10%



chocolate
RAL 8017



moka
NCS S4010 Y 30R



areia
NCS S3005 Y50S



creme
RAL 1015



negro
RAL 9005



antracite
RAL 7011



gris
RAL 7035



branco
RAL 9003

As bases de duche são revestidas a GEL COAT caracterizado por:

- Zero absorção de água.
- Dureza de 45 na escala de Barcol.
- Alta resistência a riscos.
- Anti-bacteriológico.
- Anti-derrapante.
- Resistente a altas temperaturas.
- Resistente a agentes químicos.
- Personalizável de acordo com as necessidades do cliente.
- Espessura de aprox. 3 cm.

Nos receveurs sont recouverts avec GEL COAT qui se caractérise par:

- Nulle absorption de l'eau.
- Dureté Barcol: 45.
- Étonnante résistance aux rayures.
- Antibactérienne.
- Antidérapant.
- Résistance aux hautes températures.
- Agent chimiques.
- Personnalisable selon les demandes des clients.
- Épaisseur dureceveur: 3 cm environ.

Our shower trays are covered by GEL COAT characterized by:

- Zero water absorption.
- 45 Barcol hardness.
- High scratch resistance.
- Antibacterial.
- Anti-slip.
- High temperature resistance.
- Chemical agents.
- Customizable according to customer needs.
- Its width is approximately 3 cm.

Nuestros platos están recubiertos en GEL COAT caracterizado por:

- Nula absorción del agua.
- Dureza en la escala de Barcol de 45.
- Alta resistencia al rayado.
- Antibacterias.
- Antideslizante.
- Resiste el cambio de temperatura.
- Agentes químicos.
- Personalizable por el cliente.
- Su grosor es de 3 cm. aprox.



Level Up

Atreva-se a ser diferente!





Comprimento Length longueur Länge / Largo	BLACK AND WHITE Largura / width / Largeur / Breite / Ancho		
	70 cm	80 cm	90 cm
70 cm	B135/189	-	-
80 cm	B154/216	B176/246	-
90 cm	B173/243	B198/277	B223/312
100 cm	B193/270	B220/308	B248/347
110 cm	B212/296	B242/339	B272/381
120 cm	B231/323	B264/370	B297/416
130 cm	B250/350	B286/400	B322/450
140 cm	B270/377	B308/431	B347/485
150 cm	B289/404	B330/462	B371/520
160 cm	B308/431	B352/493	B396/554
170 cm	B327/458	B374/524	B421/589
180 cm	B347/485	B396/554	B446/624
190 cm	B366/512	B418/585	B470/658
200 cm	B385/539	B440/616	B495/693
210 cm	B404/566	B462/647	B520/728

Obs.

> Nas dimensões intermédias o código correspondente é o da medida maior (ex. 164x78cm = 170x80cm)

Obs.

> In the intermediate measures the code is over the larger measure (ex. 164x78cm = 170x80cm)

Obs.

> Pour une dimension intermédiaire considérer la dimension supérieure (ex. 164x78cm = 170x80cm)

Obs.

> En una medida intermedia del código está sobre la medida más grande (ex. 164x78cm = 170x80cm)

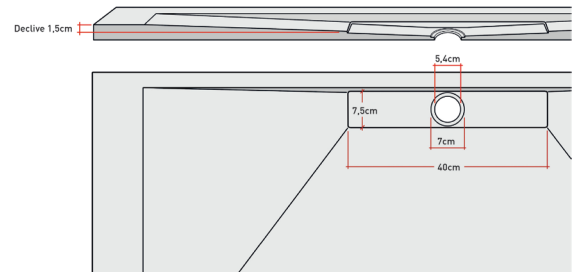
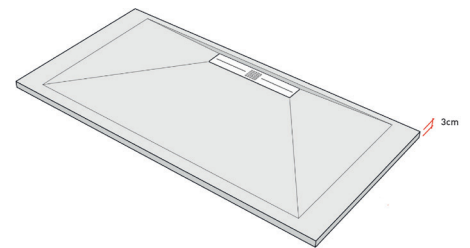
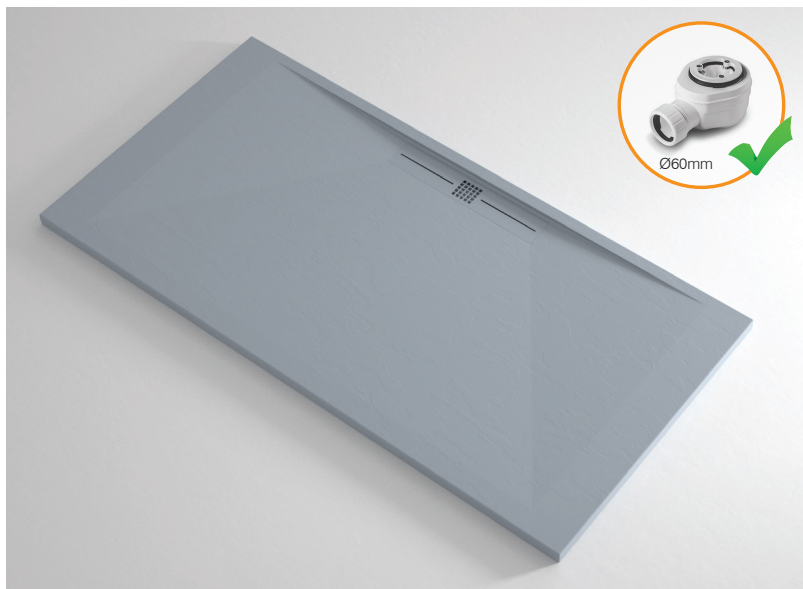

- ACABAMENTO: LISO MATE
- SUPERFÍCIE: GEL COAT
- ESPESSURA: 3cm
- OUTRAS CORES: + 10%
- GRELHA À COR



chocolate
RAL 8017



moka
NCS S4010 Y 30R



areia
NCS S3005 Y505



creme
RAL 1015



negro
RAL 9005



antracite
RAL 7011



gris
RAL 7035



branco
RAL 9003

As bases de duche são revestidas a GEL COAT caracterizado por:

- Zero absorção de água.
- Dureza de 45 na escala de Barcol.
- Alta resistência a riscos.
- Anti-bacteriológico.
- Anti-derrapante.
- Resistente a altas temperaturas.
- Resistente a agentes químicos.
- Personalizável de acordo com as necessidades do cliente.
- Espessura de approx. 3 cm.

Nos receveurs sont recouverts avec GEL COAT qui se caractérise par:

- Nulle absorption de l'eau.
- Dureté Barcol: 45.
- Étonnante résistance aux rayures.
- Antibactérienne.
- Antidérapant.
- Résistance aux hautes températures.
- Agent chimiques.
- Personnalisable selon les demandes des clients.
- Épaisseur dureceveur: 3 cm environ.

Our shower trays are covered by GEL COAT characterized by:

- Zero water absorption.
- 45 Barcol hardness.
- High scratch resistance.
- Antibacterial.
- Anti-slip.
- High temperature resistance.
- Chemical agents.
- Customizable according to customer needs.
- Its width is approximately 3 cm.

Nuestros platos están recubiertos en GEL COAT caracterizado por:

- Nula absorción del agua.
- Dureza en la escala de Barcol de 45.
- Alta resistencia al rayado.
- Antibacterias.
- Antideslizante.
- Resiste el cambio de temperatura.
- Agentes químicos.
- Personalizable por el cliente.
- Su grosor es de 3 cm. aprox.

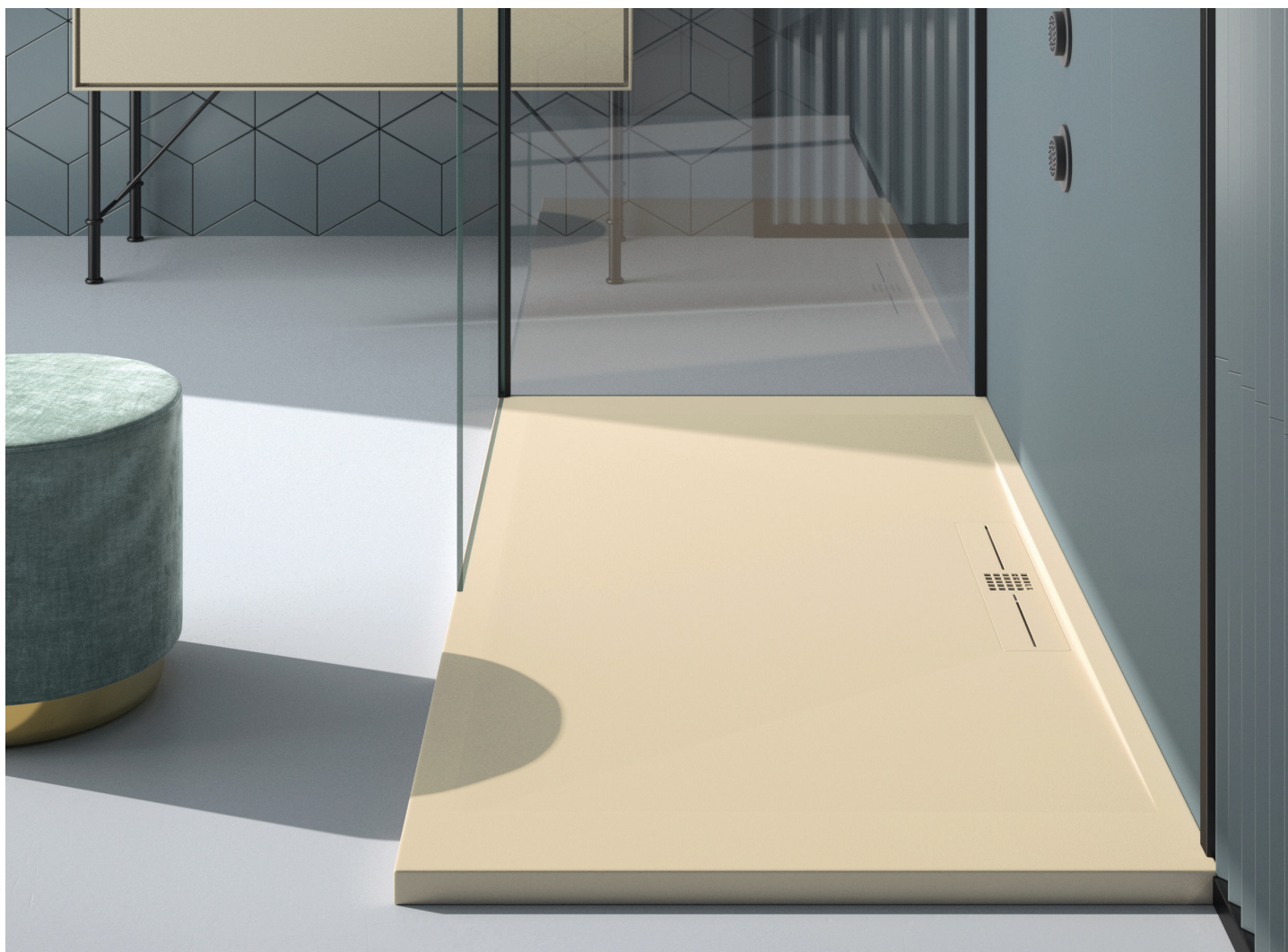
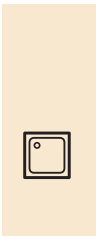

Comprimento Length Longueur Länge / Largo	PRETO & BRANCO / BLACK & WHITE Largura / width / Largeur / Breite / Ancho						
	70 cm	80 cm	90 cm	100 cm	110 cm	120 cm	130 cm
90 cm	B320/448	B340/476	B360/540	B430/602	B560/784	B670/938	B810/1134
100 cm	B340/476	B360/504	B390/546	B460/644	B600/840	B720/1008	B860/1204
110 cm	B360/504	B390/546	B410/574	B500/700	B660/924	B790/1106	B950/1330
120 cm	B380/532	B420/588	B450/630	B540/756	B710/994	B850/1190	B1020/1428
130 cm	B400/560	B440/616	B470/658	B560/784	B730/1022	B880/1232	B1060/1484
140 cm	B420/588	B450/630	B490/686	B590/826	B760/1064	B910/1274	B1090/1526
150 cm	B440/616	B460/644	B500/700	B600/840	B770/1078	B930/1302	B1120/1568
160 cm	B460/644	B480/672	B520/728	B610/854	B800/1120	B960/1344	B1150/1610
170 cm	B480/672	B520/728	B600/840	B720/1008	B920/1288	B1100/1540	B1230/1722
180 cm	B500/700	B540/756	B620/868	B740/1036	B960/1344	B1150/1610	B1370/1918
190 cm	B550/770	B580/812	B660/924	B790/1106	B1020/1428	B1220/1708	B1460/2044
200 cm	B570/798	B600/840	B690/966	B820/1148	B1070/1498	B1290/1806	B1540/2156
210 cm	B600/840	B620/868	B710/994	B850/1190	B1130/1582	B1350/1890	B1625/2275
220 cm	B660/924	B710/994	B820/1148	B940/1316	B1180/1652	B1420/1988	B1700/2380
230 cm	B730/1022	B820/1148	B940/1316	B1030/1442	B1230/1722	B1490/2086	B1790/2506
240 cm	B800/1120	B940/1316	B1040/1456	B1130/1582	B1310/1834	B1560/2184	B1880/2632
250 cm	B920/1288	B1130/1582	B1250/1750	B1300/1820	B1360/1940	B1640/2296	B1980/2772

Obs.
> Nas dimensões intermédias o código correspondente é o da medida maior (ex. 164x78cm = 170x80cm)

Obs.
> In the intermediate measures the code is over the larger measure (ex. 164x78cm = 170x80cm)

Obs.
> Pour une dimension intermédiaire considérer la dimension supérieure (ex. 164x78cm = 170x80cm)

Obs.
> En una medida intermedia del código está sobre la medida más grande (ex. 164x78cm = 170x80cm)

- ACABAMENTO: ARDÓSIA MATE
- SUPERFÍCIE: GEL COAT
- ESPESSURA: 4,5cm
- MOLDURA: 6cm
- OUTRAS CORES: + 10%
- GRELHA À COR



A LARGURA	B COMPRIMENTO	D DISTÂNCIA AO CENTRO
70	70	35
80	80	40
90	90	45
70 - 100	90	35
70 - 100	100 - 160	35
70 - 100	170 - 250	60
110 - 130	110 - 120	35
110 - 130	130 - 160	60
110 - 130	170 - 250	60

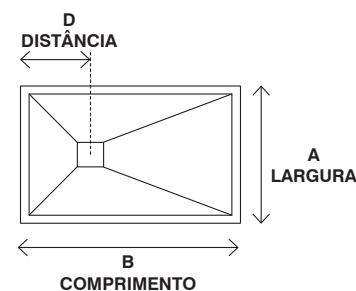
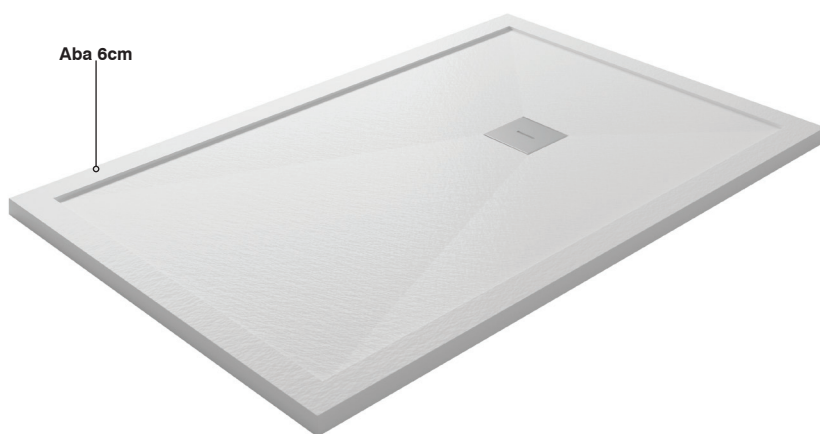

chocolate
RAL 8017



moka
NCS S4010 Y 30R



areia
NCS S3005 Y505



creme
RAL 1015



negro
RAL 9005



antracite
RAL 7011



gris
RAL 7035



branco
RAL 9003

As bases de duche são revestidas a GEL COAT caracterizado por:

- Zero absorção de água.
- Dureza de 45 na escala de Barcol.
- Alta resistência a riscos.
- Anti-bacteriológico.
- Anti-derrapante.
- Resistente a altas temperaturas.
- Resistente a agentes químicos.
- Personalizável de acordo com as necessidades do cliente.
- Espessura de aprox. 3 cm.

Nos receveurs sont recouverts avec GEL COAT qui se caractérise par:

- Nulle absorption de l'eau.
- Dureté Barcol: 45.
- Étonnante résistance aux rayures.
- Antibactérienne.
- Antidérapant.
- Résistance aux hautes températures.
- Agent chimiques.
- Personnalisable selon les demandes des clients.
- Épaisseur dureceur: 3 cm environ.

Our shower trays are covered by GEL COAT characterized by:

- Zero water absorption.
- 45 Barcol hardness.
- High scratch resistance.
- Antibacterial.
- Anti-slip.
- High temperature resistance.
- Chemical agents.
- Customizable according to customer needs.
- Its width is approximately 3 cm.

Nuestros platos están recubiertos en GEL COAT caracterizado por:

- Nula absorción del agua.
- Dureza en la escala de Barcol de 45.
- Alta resistencia al rayado.
- Antibacterias.
- Antideslizante.
- Resiste el cambio de temperatura.
- Agentes químicos.
- Personalizable por el cliente.
- Su grosor es de 3 cm. aprox.

Edge

Para grandes proyectos,
grandes soluções!



Comprimento Length / Longueur Länge / Largo	PRETA & BRANCA / BRANCA / WHITE Largura / width / Largeur / Breite / Ancho			
	70 cm	80 cm	90 cm	100 cm
70 cm	B720/1008	-	-	-
80 cm	B775/1085	B785/1099	-	-
90 cm	B840/1176	B845/1183	B885/1239	-
100 cm	B900/1260	B930/1302	B950/1330	B1070/1498
110 cm	B940/1316	B1020/1428	B1060/1484	B1170/1638
120 cm	B970/1358	B1025/1435	B1070/1498	B1180/1652
130 cm	B980/1372	B1065/1491	B1100/1540	B1220/1708
140 cm	B1030/1442	B1095/1533	B1130/1582	B1250/1750
150 cm	B1130/1582	B1230/1722	B1275/1785	B1400/1960
160 cm	B1150/1610	B1310/1834	B1320/1848	B1465/2051
170 cm	B1225/1715	B1350/1890	B1400/1960	B1560/2184
180 cm	B1280/1792	B1360/1904	B1415/1981	B1590/2226
190 cm	B1345/1883	B1430/2002	B1470/2058	B1630/2282
200 cm	B1395/1953	B1480/2072	B1540/2156	B1710/2394
210 cm	B1455/2037	B1550/2170	B1600/2240	B1770/2478
220 cm	B1500/2100	B1580/2212	B1660/2324	B1875/2625
230 cm	B1560/2184	B1635/2289	B1700/2380	B1910/2674
240 cm	B1680/2352	B1700/2380	B1780/2492	B2000/2800



OUTRAS DIMENSÕES SOB ORÇAMENTO, CONTACTE-NOS.
Other dimensions under request, contact us.
Autres dimensions sur mesure, nous consulter.



TAMPA EM KRION
INCLUIDA

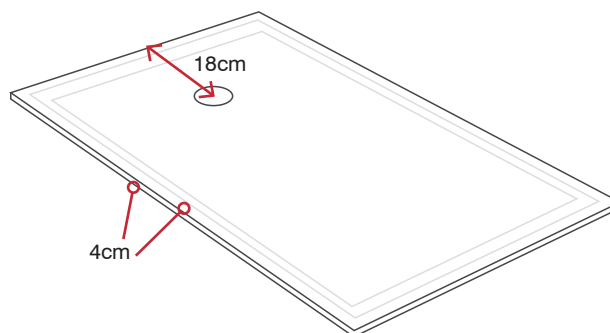

branco
mate

É um material cálido ao tato e similar à pedra natural. Este material é composto por dois terços de minerais naturais (ATH: Trihidrato de Alumina) e uma baixa percentagem de resinas de grande resistência.

Esta composição fornece ao KRION® particularidades exclusivas: carência de poros, anti-bactérias, sem nenhum tipo de aditivo, dureza, resistência, durabilidade, facilidade de reparação, pouca manutenção e fácil limpeza.

It is a material that is warm to the touch and similar to natural stone. It is made of two-thirds natural minerals (ATH - aluminium trihydrate) and a low percentage of high-resistance resins.

This composition gives Krion™ a number of exclusive features: it does not have any pores, it is antibacterial without any type of additive, it is hard-wearing, highly resistant and easy to repair, only requires minimum maintenance and is easy to clean.

Il s'agit d'un matériau chaud au toucher et similaire à la pierre naturelle. Ce matériau se compose de deux tiers de minéraux naturels (ATH : trihydrate d'alumine) et d'un faible pourcentage de résines à grande résistance.

Cette composition du KRION® le dote de particularités clairement exclusives: inexistence de pores, propriétés antibactériennes sans aucun type d'additif, dureté, résistance, durabilité, facilité de réparation, entretien minime et nettoyage facile.

Es un material cálido al tacto y similar a la piedra natural. Este material está compuesto por dos tercios de minerales naturales (ATH: Trihidrato de Alumina) y un bajo porcentaje de resinas de gran resistencia.

Esta composición dota a Krion® de unas claras particularidades exclusivas: carencia de poros, antibacterias sin ningún tipo de aditivo, dureza, resistencia, durabilidad, facilidad de reparación, escaso mantenimiento y fácil limpieza.

Strong

Prodotto in KRION®



Edge / Level Up / Side / Mineral

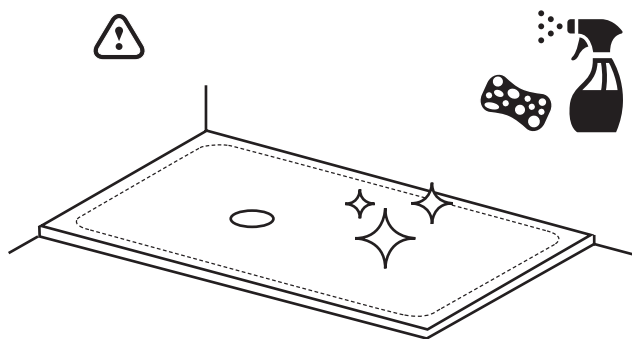

Manutenção e limpeza

As bases de chuveiro podem ser limpas com a maioria dos produtos de limpeza. Recomenda-se usar uma esponja e água com sabão para limpar a base de chuveiro. Nunca use uma esponja abrasiva.

IMPORTANTE:

Se necessitar de desentupir o sifão ou os tubos de evacuação, tenha atenção para não salpicar os produtos contendo ácido sulfúrico ou soda cáustica na base de chuveiro. Recomenda-se usar um funil para despejar este tipo de produto diretamente no sifão. Esses produtos podem danificar irreversivelmente a superfície da base de chuveiro.

Maintenance and cleaning

Shower trays can be cleaned with almost all common cleaning products. It is recommended to use a sponge and soapy water to clean the shower tray. Never use abrasive sponge.

IMPORTANT:

If you must unclog the siphon or the evacuation tubes, it is very important to be careful not to overturn the shower tray. products containing sulfuric acid or caustic soda. It is recommended to use a funnel to pour this type of product directly into the siphon. These products could irreversibly damage the surface of the shower tray.

Entretien et nettoyage

Les bacs à douche peuvent être nettoyés avec presque tous les produits de nettoyage courants. Il est recommandé d'utiliser une éponge et de l'eau savonneuse pour nettoyer le receveur de douche. Ne jamais utiliser d'éponge abrasive.

IMPORTANT:

Si vous devez déboucher le siphon ou les tuyaux d'évacuation, il est très important de veiller à ne pas jeter les produits contenant de l'acide sulfurique ou de la soude caustique sur le receveur de la douche. Il est recommandé d'utiliser un entonnoir pour verser ce type de produit directement dans le siphon. Ces produits pourraient endommager de manière irréversible la surface du receveur de douche.

Mantenimiento y limpieza

Los platos de ducha se pueden limpiar con casi todos los productos de limpieza corrientes. Es recomendado utilizar una esponja y agua jabonosa para la limpieza del plato de ducha. Jamás utilizar esponja abrasiva.

IMPORTANTE:

Si deben desatascar el sifón o los tubos de evacuación, es muy importante tener cuidado de no volcar sobre el plato de ducha los productos que contiene ácido sulfúrico o sosa cáustica. Es recomendado utilizar un embudo para echar este tipo de producto directamente en el sifón. Estos productos podrían dañar de manera irreversible la superficie del plato de ducha.

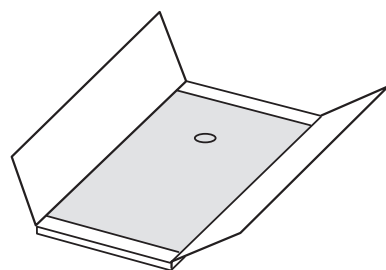

- ✓ Cor / Color
- ✓ Dimensão / Dimension
- ✓ Válvula / Valve

Antes da instalação

Verifique o estado da base de chuveiro e verifique se corresponde à cor e acabamento selecionados. Antes da instalação, a base deve ser sempre armazenada na horizontal ou na vertical, nunca em ângulo, pois isso pode deformá-la. Todas as bases de chuveiro podem ser cortadas com um disco de diamante radial. A peça cortada nunca terá o mesmo acabamento que os outros lados, pelo que a zona cortada deve ser aplicada em direção à parede. Não é aconselhável colocar a base de chuveiro sobre suportes/pernas. Isso pode deformar a base e, nesse caso, perderá a garantia.

Before installation

Check the correct condition of the shower tray and verify that it corresponds to the color and the selected color. Before installation the plate should always be stored horizontally or vertically, but never making an angle, as this could deform it. All shower trays can be cut with a diamond disc radial. The cut part will never have the same finish as the other sides, so the cut part should go towards the wall. It is not advisable to put the shower tray on legs/suports. This could deform the plate and in this case, it would lose the guarantee.

Avant l'installation

Vérifiez le bon état du receveur et assurez-vous qu'il correspond à la couleur et à la dimension sélectionnées. Avant l'installation, le receveur doit toujours être stockée horizontalement ou verticalement, mais jamais un angle, cela pourrait la déformer. Tous les bacs à douche peuvent être coupés avec un disque en diamant radial. La partie coupée n'aura jamais la même finition que les autres côtés, elle doit donc aller vers le mur. Il n'est pas conseillé de poser le receveur de douche sur les pieds. Cela pourrait déformer le receveur et dans ce cas, la garantie serait perdue.

Antes de la instalación

Controlar el correcto estado del plato de ducha y verificar que corresponde al acabado y al color escogido. Antes de su instalación el plato debe ser almacenado siempre en horizontal o vertical, pero nunca haciendo ángulo, pues esto podría deformarlo. Todos los platos de ducha pueden ser recortados con una radial con disco diamante. La parte cortada jamás tendrá el mismo acabado que los otros lados, por eso la parte cortada debe ir hacia la pared. No es recomendable poner el plato de ducha sobre patas. Esto podría deformar el plato y en este caso, perdería la garantía.

Strong

Manutenção e limpeza

Evitar os produtos químicos prejudiciais, tais como desentupidores e diluentes de tinta. No caso de ocorrer, a mancha deve ser retirada quanto antes com bastante água e sabão para evitar a degradação. Não expor as superfícies à ação de produtos químicos fortes por um tempo prolongado. Tenha especial cuidado com os diluentes, acetonas, limpa fornos, cloreto de metilo e desentupidores de canos, em caso de exposição accidental enxaguar com bastante água.

1. Para uma limpeza onde a superfície se tenha manchado ou simplesmente se quiser realizar a limpeza habitual.

Esta limpeza pode ser realizada com um pano normal ou de microfibra, esponja e com um agente de limpeza como água quente ou um produto de limpeza doméstico que contenha tensoativos.

O procedimento consiste em humedecer o pano normal ou de microfibra, esponja e a superfície com o agente de limpeza; esfregar sempre realizando movimentos circulares de modo a realizar uma limpeza homogênea em toda a superfície. Ao terminar, é importante secar bem a superfície com um papel, pano seco e macio ou de microfibra, para desta forma não deixar restos do agente de limpeza.

2. No caso de no ponto 1 a mancha não ter sido eliminada.

Seguir o processo anterior, mas utilizando como agente de limpeza em creme que contenha micropartículas levemente abrasivas. O agente de limpeza deve-se aplicar diretamente sobre a mancha e devem-se realizar movimentos circulares com o pano ou esponja sem aplicar pressão. Ao terminar, é importante enxaguar com água e secar bem a superfície com um papel, pano seco e macio ou microfibra, para desta forma não deixar restos do agente de limpeza.

Maintenance and cleaning

Avoid the use of noxious chemical substances, like drain cleaners or paint stripper. If any such liquid is spilled onto the surface, clean it up as promptly as possible using plenty of soapy water to avoid damage. Do not expose KRION™ surfaces to strong chemical products for prolonged periods of time. Be particularly careful with solvents, acetates, oven cleaners, methyl chloride and drain cleaners. In the event of the surface's accidental exposure to these products, rinse with plenty of water.

1. Regular cleaning and stain removal.

This should be done with a cloth, sponge or microfibre cleaning towel and a cleaning agent, such as hot water or a surfactant household cleaner. Dampen the cloth, sponge or microfibre cleaning towel and the surface with the cleaning agent, and rub the whole surface uniformly, using circular movements. When you have finished cleaning it, dry the surface well with a paper, cleaning towel or soft dry cloth. In this way, any remains of the cleaning product will be removed.

2. If stains cannot be removed as indicated in point one.

Follow the above procedure again, but this time use a different cleaning product, such as a cream-based one with slightly abrasive microparticles. The cleaning product should be applied directly to the stain and then it should be rubbed in circular motion with the cleaning towel, cloth or sponge without applying pressure. When the stain has disappeared, the cleaning product can be applied to the whole surface and it can be uniformly cleaned. Afterwards, remember to rinse the surface with water and dry it well with a paper, cleaning towel or soft dry cloth so that no remains of the cleaning product are left.

Entretien et nettoyage

Évitez les produits chimiques préjudiciables tels que les produits nettoyant les tuyauteries et les dissolvants de peinture. Si elle se produit, la tache doit être retirée le plus vite possible avec de l'eau savonneuse en abondance pour éviter la dégradation. Ne pas exposer les surfaces à l'action de produits chimiques forts pendant une durée prolongée. Faites particulièrement attention aux solvants, acétones, produits nettoyants pour le four, chlorure de méthylène et produits nettoyants pour canalisations, en cas d'exposition accidentelle, rincez abondamment à l'eau.

1. Pour un nettoyage lorsque la surface en a été tachée ou simplement pour la réalisation d'un nettoyage habituel.

Ce nettoyage peut être mené à bien à l'aide d'un linge, d'une éponge ou d'une lavette en microfibre et avec un agent nettoyant tel que l'eau chaude ou un produit nettoyant ménager contenant des agents tensoactifs. La procédure consiste à humidifier le linge, l'éponge ou la lavette en microfibre et la surface de avec l'agent nettoyant ; il faut toujours frotter avec des mouvements circulaires pour réaliser un nettoyage homogène sur toute la surface. Lorsque tout le nettoyage est terminé, il est important de bien sécher la surface à l'aide d'un papier, d'une lavette ou d'un linge sec et doux. Pour garantir ainsi qu'il ne reste plus d'agent nettoyant.

2. Dans le cas où la tache n'aurait pas été éliminée avec l'étape du point 1.

Il faudra procéder tel que décrit précédemment mais en utilisant comme agent nettoyant un produit différent, tel qu'un produit nettoyant en crème contenant des microparticules légèrement abrasives. L'agent nettoyant sera directement appliqué sur la tache et il faudra réaliser des mouvements circulaires à l'aide de la lavette, du linge ou de l'éponge sans appliquer aucune pression. Lorsque la tache aura été éliminée, on peut appliquer un agent nettoyant sur toute la surface en et effectuer un nettoyage homogène de toute la surface. Lorsque tout le nettoyage est terminé, il est important de rincer à l'eau et de bien sécher la surface à l'aide d'un papier, d'une lavette ou d'un linge sec et doux. Pour garantir ainsi qu'il ne reste plus d'agent nettoyant.

Mantenimiento y limpieza

Evite los productos químicos perjudiciales, tales como limpiadores de desagües y disolventes de pintura. En caso de producirse, la mancha debe ser retirada lo antes posible con abundante agua jabonosa para evitar la degradación. No exponer las superficies a la acción de productos químicos fuertes por un tiempo prolongado. Tenga especial cuidado con los disolventes, acetonas, limpia-hornos, cloruro de metilo y limpiadores de desagües, en caso de exposición accidental aclarar con abundante agua.

1 - Para una limpieza donde la superficie haya sido manchada o simplemente que se desee realizar una limpieza habitual.

Esta limpieza puede ser llevada a cabo con un paño, esponja o bayeta de microfibra y con un agente limpiador como agua caliente o un limpiador doméstico que contenga tensoactivos. El procedimiento consiste en humedecer el paño, esponja o bayeta de microfibra y la superficie con el agente limpiador; se frota siempre realizando movimientos circulares para realizar una limpieza homogénea en toda la superficie. Al terminar de hacer toda la limpieza es importante secar bien la superficie con un papel, bayeta o paño seco y suave. Para de esta forma no dejar restos de agente limpiador.

2- En el caso que en el punto 1 la mancha no haya sido eliminada.

Se procederá de la misma forma descrita anteriormente pero utilizando como agente limpiador un producto diferente, como puede ser un producto limpiador en crema que contenga micropartículas levemente abrasivas. El agente limpiador se aplicará directamente sobre la mancha y se procederá a realizar movimientos circulares con la bayeta, paño o esponja sin aplicar presión alguna. Al terminar de hacer toda la limpieza es importante aclarar con agua y secar bien la superficie con un papel, bayeta o paño seco y suave. Para de esta forma no dejar restos de agente limpiador.





Novos, agora com rebordo externo
para facilitar o acabamento.

Nouvelles solutions avec rebord extérieur pour
faciliter la finition de la pose

Nichos - Solid Surface

BRANCO / WHITE / BLANC / WEISS / BLANCO
Mate / Matt

PRETO / BLACK / NOIR / SCHWARZ / NEGRO
Mate / Matt

① RNI295295QBRC

S289/405

Dim.: 29,5x29,5x8cm

Pack: 4 kg / 0,06 m³



① RNI295295QPRT

S340/476

Dim.: 29,5x29,5x8cm

Pack: 4 kg / 0,06 m³



② RNI295445RBRC

S357/500

Dim.: 29,5x44,5x8cm

Pack: 5,70 kg / 0,06 m³



② RNI295445RPRT

S425/595

Dim.: 29,5x44,5x8cm

Pack: 5,7 kg / 0,06 m³



③ RNI295595RBRC

S425/595

Dim.: 29,5x59,5x8cm

Pack: 6,5 kg / 0,06 m³



③ RNI295595RPRT

S510/714

Dim.: 29,5x59,5x8cm

Pack: 6,5 kg / 0,06 m³



④ RNI295895RBRC

S561/786

Dim.: 29,5x89,5x8cm

Pack: 9 kg / 0,06 m³



④ RNI295895RPRT

S680/952

Dim.: 29,5x89,5x8cm

Pack: 9 kg / 0,06 m³



DUPLO / DOUBLE / DOBLE / DOPPELT

⑤ RNI295595RBRC DPL

S459/643

Dim.: 29,5x59,5x8cm

Pack: 7,2 kg / 0,06 m³



DUPLO / DOUBLE / DOBLE / DOPPELT

⑤ RNI295595RPRT DPL

S561/786

Dim.: 29,5x59,5x8cm

Pack: 7,2 kg / 0,06 m³



TRIPLO / TRIPLE / DOBLE / VERDREIFACHEN

⑥ RNI295895RBRC TRI

S629/881

Dim.: 29,5x89,5x8cm

Pack: 10,5 kg / 0,06 m³



TRIPLO / TRIPLE / DOBLE / VERDREIFACHEN

⑥ RNI295895RPRT TRI

S782/1095

Dim.: 29,5x89,5x8cm

Pack: 10,5 kg / 0,06 m³



OUTRAS DIMENSÕES SOB ORÇAMENTO. CONTACTE-NOS.
OTHER DIMENSIONS UNDER REQUEST, CONTACT US.
AUTRES DIMENSIONS SUR MESURE, NOUS CONSULTER.

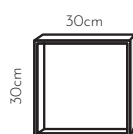

①

SINGULAR
29,5x29,5x8cm

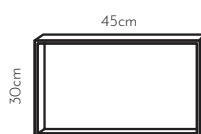

②

SINGULAR
29,5x44,5x8cm

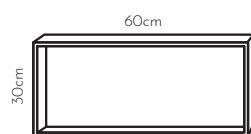

③

SINGULAR
29,5x59,5x8cm



④

SINGULAR
29,5x89,5x8cm

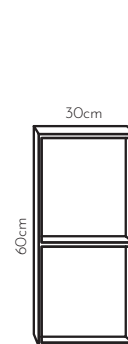

⑤

DUPLO
29,5x59,5x8cm

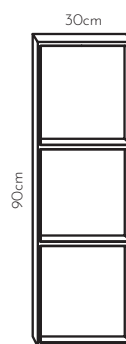

⑥

TRIPLO
29,5x89,5x8cm

Nichos Porcelânicos



Nichos Porcelânicos

Sob orçamento noutras referências



36x66
CONKRETUS CINZA

Nicho Konkretus Cinza Mate **N500/700**

Dim.: 36 x 66 x 10 cm / 15Kg / 0,05m³

Ref.: RN3666COCI



NEW +



36x96
ORO BIANCO

Nicho Branco Mate **N550/770**

Dim.: 36 x 96 x 10 cm / 15Kg / 0,05m³

Ref.: RN3696ORB



36x66
BLACK MATE

Nicho Preto Mate **N500/700**

Dim.: 36 x 66 x 10 cm / 15Kg / 0,05m³

Ref.: RN3666BLKMA



NEW +

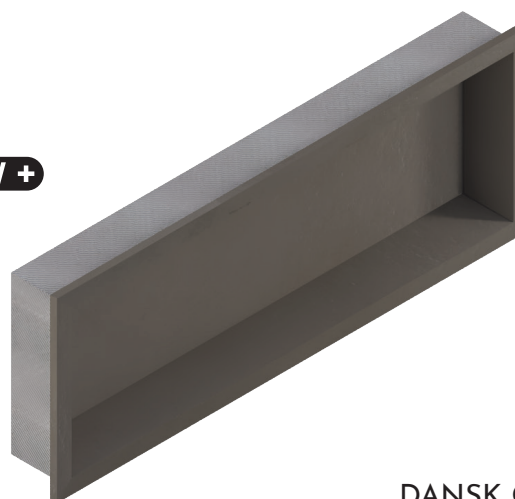

36x96
DANSK CEMENT

Nicho Konkretus Cinza Mate **N550/770**

Dim.: 36 x 96 x 10 cm / 15Kg / 0,05m³

Ref.: RN3696DCG

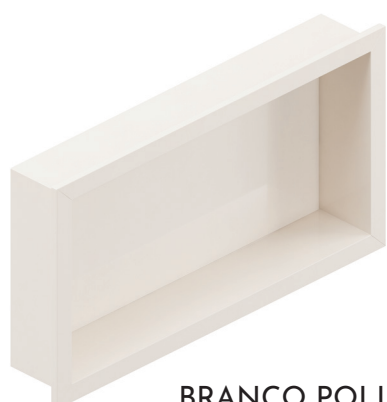

36x66
BRANCO POLIDO OU MATE

Nicho Branco Brilho **N500/700**

Dim.: 36 x 66 x 10 cm / 15Kg / 0,05m³

Ref.: RN3666WHPO



Cabides Porcelânicos

Sob orçamento noutras referências



RAC9CMAR
N75/105



RAC7CMAR
N68/95



RAC5CMAR
N60/84

NEW +



BRANCO MATE E ARGENTO MATE

Nicho Branco Mate **N500/700**

Dim.: 36 x 66 x 10 cm / 15Kg / 0,05m³

Ref.: RN3666WHMA



Cabide Porcelânico PUNTO

Dim.: Ø5cm N60/84 • Ø7cm N68/95 • Ø9cm N75/105

Ref.: RAC5CMOFFW / RAC7CMOFFW / RAC9CMOFFW

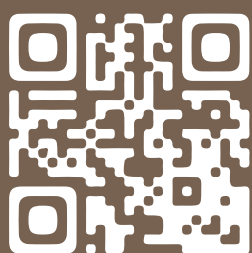

IOS



ANDROID



SEDE • SHOWROOM • WAREHOUSE - Portugal

Avenida 16 de Maio, nº 1290
3880-102 Ovar, Portugal
T.: (+351) 256 790 140
Email: geral@rubicer.pt

Showrooms:

Ovar - Portugal
Algarve - Portugal
Castellón - Espanha

SHOWROOM & WAREHOUSE - Espanha

RUBICER Europa, S.L.
Avda. Mediterraneo, 97
12200 ONDA (Castellon)
T.: (+34) 964 187 760 / (+34) 964 186 759
Email: geral@rubicer.pt

www.rubicer.pt